

VISION

installation:innovation

TECHCONNECT AMPLIFIER OWNERS MANUAL



www.visionaudiovisual.com/techconnect/tc2-amp2

TECHCONNECT AMPLIFIER OWNERS MANUAL

Thanks for choosing the Vision TC2-AMP2 digital amplifier! In order to obtain the best performance please be sure to read this owner's manual and use your product only in accordance with the instructions.

CONFORMITY

The product described in this owner manual is in compliance with RoHS (EU directive 2002/95/EC), and WEEE (EU directive 2002/96/EC) standards. Certificates including SGS reports are available on request. This product should be returned to the place of purchase at the end of its useful life for recycling.

WARNINGS



CAUTION
RISK OF ELECTRIC SHOCK
DO NOT OPEN



CAUTION: TO REDUCE THE RISK OF ELECTRIC SHOCK DO NOT REMOVE COVER (OR BACK). NO USER-SERVICEABLE PARTS INSIDE. REFER SERVICING TO QUALIFIED SERVICE PERSONNEL.

 The lightning flash with arrowhead symbol, within an equilateral triangle, is intended to alert the user to the presence of uninsulated "dangerous voltage" within the product's enclosure that may be of sufficient magnitude to constitute a risk of electric shock to persons.

 The exclamation point within an equilateral triangle, is intended to alert the user to the presence of important operating and maintenance (servicing) instructions in the literature accompanying the appliance.

WARNING: TO REDUCE THE RISK OF FIRE OR ELECTRIC SHOCK, DO NOT EXPOSE THIS APPLIANCE TO RAIN OR MOISTURE.

All products are designed and imported into the EU by 'Vision' who is wholly owned by 'Azlan Logistics Ltd.', Registered in England Nr. 04625566 at Lion House, 4 Pioneer Business Park, Clifton Moor, York, YO30 4GH.



USE ONLY DOMESTIC AC OUTLETS

Connecting the unit to an outlet supplying a higher voltage may create a fire hazard.

HANDLE THE POWER CORD WITH CARE

Do not disconnect the plug from the AC outlet by pulling the cord; always pull the plug itself. Pulling the cord may damage it. If you do not intend to use your unit for any considerable length of time, unplug the unit. Do not place furniture or other heavy objects on the cord, and try to avoid dropping heavy objects on it. Do not tie a knot in the power cord. Not only could the cord be damaged, but a short circuit could also be caused with a consequent fire hazard.

PLACE OF INSTALLATION

Avoid installing this product under the following conditions:

- Moist or humid places
- Places exposed to direct sunlight or close to heating equipment
- Extremely cold locations
- Places subject to excessive vibration or dust
- Poorly ventilated places

Do not expose this product to dripping or splashing. **DO NOT PLACE OBJECTS FILLED WITH LIQUIDS ON OR NEAR THIS PRODUCT!**

MOVING THE UNIT

Before moving the unit, be sure to pull out the power cord from the AC outlet and disconnect the interconnection cords with other units.

WARNING SIGNS

If you detect an abnormal smell or smoke, turn this product off immediately and unplug the power cord. Contact your reseller or Vision.

PACKAGING

Save all packing material. It is essential for shipping in the event the unit ever needs repair.

IF ORIGINAL PACKAGING IS NOT USED TO RETURN THE UNIT TO THE SERVICE CENTRE, DAMAGE IN TRANSIT WILL NOT BE COVERED BY WARRANTY.

FRONT AND REAR CONTROL PANELS

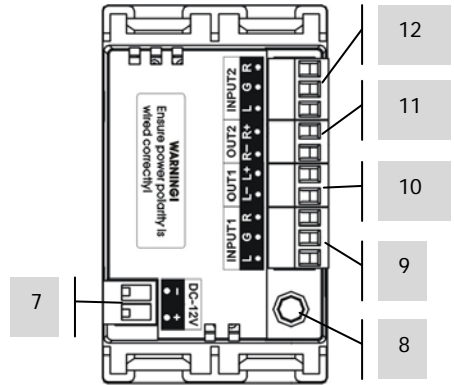
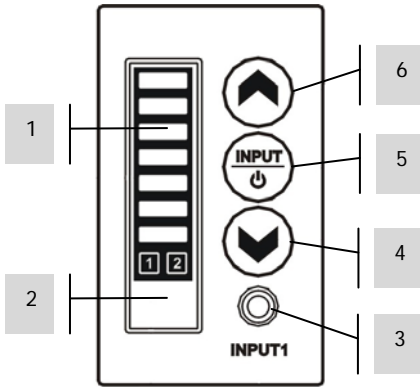

1. LED Volume Indicator
- 2 / 8. IR receiver
- 3 / 9. Input 1
4. Volume Down
5. Power Switch /Input Selector
6. Volume Up
7. Power Socket
10. Right Speaker Output
11. Left Speaker Output
12. Input 2

IR REMOTE CONTROL

1. Input 1
2. Volume Up
3. Mute
4. Input 2
5. Power On
6. Power Off
7. Volume Down

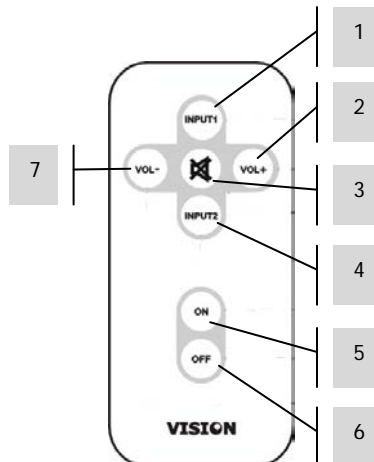

INSTALLATION INSTRUCTIONS

1. TC2 VGAF3.5MM module
2. 3-Phono module
3. TC2-AMP2 module
4. Bare-wire speaker terminals
5. UK double gang surround

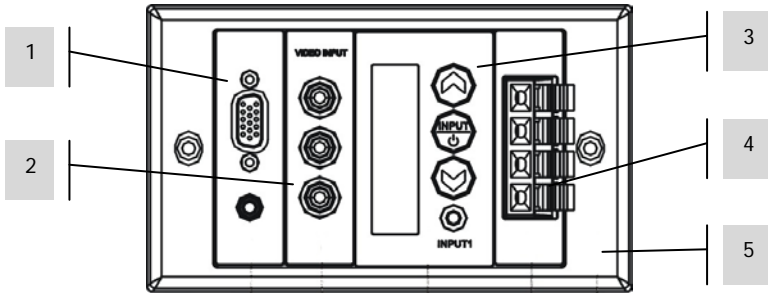

Connect as shown:

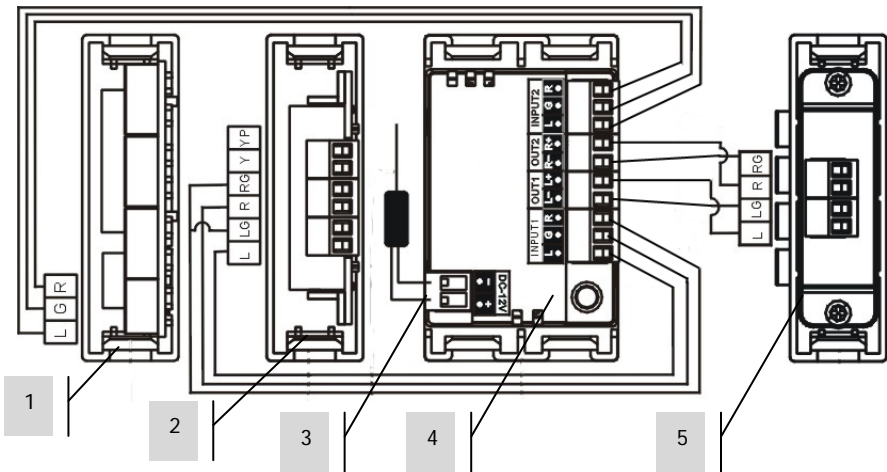

1. TC2 VGAF3.5MM module
2. 3-Phono module
3. DC Power
4. TC2-AMP2 module
5. Bare-wire speaker terminals

NOTE 1: The speaker cable must be unshielded with a gauge of no less than 0.75mm.
THE WARRANTY WILL BE VOID IF YOU USE UNSUITABLE SHIELDED CABLE.

NOTE 2: THIS IS A LOW-IMPEDANCE AMPLIFIER. DO NOT ATTEMPT TO CONNECT 100V
LINE SPEAKERS (Normally any speakers with "t" in the part code)

Alternative Configuration

1. Techconnect
2. TC2-AMP2 module
3. UK Single gang Surround
4. Power cable

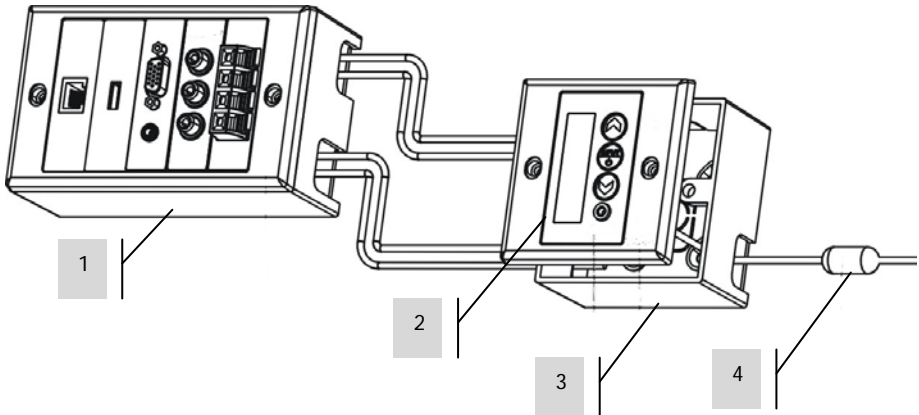

PROGRAMMING MEMORY

The Techconnect Amplifier turns on automatically when mains power turned on.

The amplifier has an adjustable memory:

Mode 1: Assumes a pre-set input and volume

Mode 2: (default) Resumes last input and volume

To view current mode and switch mode:

1. Turn amplifier off
2. Hold down **volume+** then **power** buttons for 5 seconds. Input indicator will flash 8 times showing current mode.
3. To change mode repeat step 2. Input indicator will flash 8 times showing the other mode.
4. Turn mains power off to apply change to memory.

To adjust settings for mode 1:

1. Check it is in mode 1. Set volume and input
2. Turn amplifier to off (standby)
3. Hold down **volume+** then **volume-** for 5 seconds. Input indicator will flash 8 times indicating the new setting has been saved.

TROUBLESHOOTING

If your system is not operating properly, please refer to the following information. If the problem persists, disconnect from power and contact your AV reseller immediately.

Problem	Correction
No Sound	<ul style="list-style-type: none">• Turn off and check connections.• Check output level from sources. For example, laptop volume.• The amplifier chip has temperature and overload protection. This means if the chip temperature is too extreme (outside -40°C-50°C) or the chip is overloaded, the chip will temporarily mute itself. When normal conditions return, it will resume working.
No Power light	<ul style="list-style-type: none">• Check power connections
Distortion	<ul style="list-style-type: none">• Volume too high• Loudspeakers may be worn or damaged
Sound only coming out one side	<ul style="list-style-type: none">• Turn off and switch output connections. If the side changes the amplifier is okay.• Switch input connections and check input cabling.

SPECIFICATIONS

- Power Output: 2 x 20 watts RMS @ 8 Ω
- Total Harmonic Distortion: $\leq 1\%$ (20Hz-22kHz)
- Frequency Response (line in): 20Hz~22kHz(± 2 dB)
- Signal to noise ratio (line in): ≥ 98 dB (A-weighted)
- Rating input level/impedance: Line in 500mV/50k Ω
- Power Consumption: ≤ 40 w
- Power Supply 100-240vAC 50/60Hz Max 1.2A, DC Output 12V 3A, DC Cable 3m
- Dimensions: 71 x 42 x 40mm
- Weight: 63 grams
- Colour: White

ACCESSORIES INCLUDED

- 2 x 150mm input cable
- 2 x Unshielded Speaker cable 5m long
- 1 x IR Remote Control

WARRANTY

This product comes with a 2-year return to base warranty, effective from the date of purchase. This warranty applies only to the original purchaser and is not transferable. For the avoidance of doubt, this will be taken from the information held by the appointed national distributor at the point of sale. If the product is DOA (dead on arrival), you have 21 days from purchase date to notify the national distributor via your AV reseller. The liability of the manufacturer and its appointed service company is limited to the cost of repair and/or replacement of the faulty unit under warranty, except for death or injury (EU85/374/EEC). This warranty protects you against the following:

- Failure of any components, including the power supply.
- Damage when the product is first removed from its packaging if reported within 24 hours of purchase.

If you find you do have a problem with this product, you should contact the AV reseller you purchased this product from. The original purchaser is responsible for shipment of the product to the manufacturer's appointed service centre for repair.

We will endeavour to return repaired units within 5 working days, however this may not always be possible, in which case it will be returned as soon as practicably possible. In line with our WEEE commitments, the manufacturer endeavours to replace the faulty parts of the product rather than replacing the whole unit. This warranty does not protect this product against faults caused by abuse, misuse, incorrect installation, unstable or faulty power input, which might be caused by ignoring the guidelines set out in this manual.

LEGAL DISCLAIMER: Because we are committed to improving our products, the details above may change without prior warning. This User Manual is published without warranty and any improvements or changes to the User Manual necessitated by typographical errors, inaccuracies of current information, or improvements to programs and/or equipment, may be made at any time and without notice. Such changes will be incorporated into new editions of the User Manual.